

SUCTION CUPS / Oval Curve

VOC11x23



Features and Strengths

Good for long objects with flat and curved surfaces
Strong lifting force and long life-span

Examples of use

Long flat objects, Curved surface, Metal panels, Automobile bumpers
Wood panel, Furniture



Recommended Lifting Force (Max.)

Model	Volume (cm ³)	Lifting Force (Kg) - Perpendicular			Lifting Force (Kg) - Parallel		
		- 20 kPa	- 60 kPa	- 90 kPa	- 20 kPa	- 60 kPa	- 90 kPa
VOC11x23	2.00	0.61	1.30	1.60	0.60	1.20	1.50

※ The lifting force above does not include safety factor

Material Specifications

Material	Hardness Shore (°)	Color	Temperature (°C)
NBR	60	Black	-20~110
Silicone	55	Red	-70~200
White Silicone	55	Translucent White	-70~200
White Silicone (FDA)	55	Translucent White	-70~200
High temp. Silicone	50	Blue	-70~280
Conductive Silicone	70	Smoky Black	-45~90
Urethane	60	Dark Green	0~100
Mark Free	75	Black	-10~100

Material Resistance

Description	NBR	Silicone	White Silicone	High temp. Silicone	Conductive Silicone	Urethane	Mark Free
Wear Resistance	Excellent	Good	Good	Good	Good	Excellent	Good
Oil	Excellent	Poor	Poor	Poor	Poor	Excellent	Excellent
Weather / Ozone	Fair	Excellent	Excellent	Excellent	Excellent	Excellent	Excellent
Alcohol	Good	Good	Good	Good	Good	Fair	Good
Acid	Fair	Poor	Poor	Poor	Poor	Poor	Excellent

I Build an Ordering No.

VOC11x23 - 
1. Suction Cup

1. Suction cup	Description	Weight (g)	Symbol
	Oval-Curved suction cup, 11x23mm diameter, Nitrile (NBR)	1.53	VOC11x23-N
	Oval-Curved suction cup, 11x23mm diameter, Silicone	1.48	VOC11x23-S
	Oval-Curved suction cup, 11x23mm diameter, White silicone	1.46	VOC11x23-WS
	Oval-Curved suction cup, 11x23mm diameter, White silicone (FDA)	1.46	VOC11x23-WS (FDA)
	Oval-Curved suction cup, 11x23mm diameter, High temperature silicone	1.58	VOC11x23-HS
	Oval-Curved suction cup, 11x23mm diameter, Conductive silicone	1.51	VOC11x23-CS
	Oval-Curved suction cup, 11x23mm diameter, Urethane	1.58	VOC11x23-U
	Oval-Curved suction cup, 11x23mm diameter, Mark free	1.65	VOC11x23-A

I Dimension

[Unit : mm]

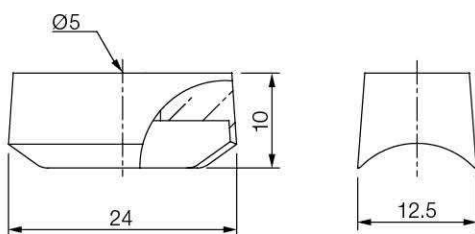

[Rubber Part]

SUCTION CUPS / Oval Curve

VOC35x90

Features and Strengths

Good for long objects with flat and curved surfaces
Strong lifting force and long life-span

Examples of use

Long flat objects, Curved surface, Metal panels, Automobile bumpers
Wood panel, Furniture



Recommended Lifting Force (Max.)

Model	Volume (cm ³)	Lifting Force (Kg) - Perpendicular			Lifting Force (Kg) - Parallel		
		- 20 kPa	- 60 kPa	- 90 kPa	- 20 kPa	- 60 kPa	- 90 kPa
VOC35x90	20.00	5.00	13.40	17.40	4.00	10.72	13.92

※ The lifting force above does not include safety factor

Material Specifications

Material	Hardness Shore (°)	Color	Temperature (°C)
NBR	60	Black	-20~110
Silicone	55	Red	-70~200
White Silicone	55	Translucent White	-70~200
White Silicone (FDA)	55	Translucent White	-70~200
High temp. Silicone	50	Blue	-70~280
Conductive Silicone	70	Smoky Black	-45~90
Urethane	60	Dark Green	0~100
Mark Free	75	Black	-10~100

Material Resistance

Description	NBR	Silicone	White Silicone	High temp. Silicone	Conductive Silicone	Urethane	Mark Free
Wear Resistance	Excellent	Good	Good	Good	Good	Excellent	Good
Oil	Excellent	Poor	Poor	Poor	Poor	Excellent	Excellent
Weather / Ozone	Fair	Excellent	Excellent	Excellent	Excellent	Excellent	Excellent
Alcohol	Good	Good	Good	Good	Good	Fair	Good
Acid	Fair	Poor	Poor	Poor	Poor	Poor	Excellent

Dimension

[Unit : mm]

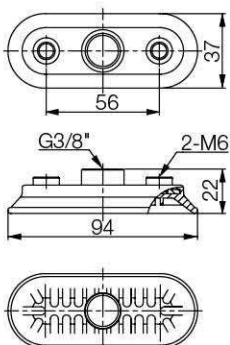

[With 38F fitting]

Build an Ordering No.

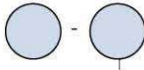
VOC35x90 -  : Pre-mounted fitting
1. Suction Cup

1. Suction cup	Description	Weight (g)	Symbol
	Oval-Curved suction cup, 35x90mm diameter, Nitrile (NBR), G3/8 female	47.18	VOC35x90-N-38F
	Oval-Curved suction cup, 35x90mm diameter, Silicone, G3/8 female	45.40	VOC35x90-S-38F
	Oval-Curved suction cup, 35x90mm diameter, White silicone, G3/8 female	44.93	VOC35x90-WS-38F
	Oval-Curved suction cup, 35x90mm diameter, White silicone (FDA), G3/8 female	44.93	VOC35x90-WS-38F (FDA)
	Oval-Curved suction cup, 35x90mm diameter, High temperature silicone, G3/8 female	45.75	VOC35x90-HS-38F
	Oval-Curved suction cup, 35x90mm diameter, Conductive silicone, G3/8 female	46.72	VOC35x90-CS-38F
	Oval-Curved suction cup, 35x90mm diameter, Urethane, G3/8 female	47.89	VOC35x90-U-38F
	Oval-Curved suction cup, 35x90mm diameter, Mark free, G3/8 female	48.97	VOC35x90-A-38F

SUCTION CUPS / Oval Curve

VOC35x110

Features and Strengths

Good for long objects with flat and curved surfaces
Strong lifting force and long life-span

Examples of use

Long flat objects, Curved surface, Metal panels, Automobile bumpers
Wood panel, Furniture



Recommended Lifting Force (Max.)

Model	Volume (cm ³)	Lifting Force (Kg) - Perpendicular			Lifting Force (Kg) - Parallel		
		- 20 kPa	- 60 kPa	- 90 kPa	- 20 kPa	- 60 kPa	- 90 kPa
VOC35x110	25.00	6.25	16.70	21.70	5.00	13.36	17.36

※ The lifting force above does not include safety factor

Material Specifications

Material	Hardness Shore (°)	Color	Temperature (°C)
NBR	60	Black	-20~110
Silicone	55	Red	-70~200
White Silicone	55	Translucent White	-70~200
White Silicone (FDA)	55	Translucent White	-70~200
High temp. Silicone	50	Blue	-70~280
Conductive Silicone	70	Smoky Black	-45~90
Urethane	60	Dark Green	0~100
Mark Free	75	Black	-10~100

Material Resistance

Description	NBR	Silicone	White Silicone	High temp. Silicone	Conductive Silicone	Urethane	Mark Free
Wear Resistance	Excellent	Good	Good	Good	Good	Excellent	Good
Oil	Excellent	Poor	Poor	Poor	Poor	Excellent	Excellent
Weather / Ozone	Fair	Excellent	Excellent	Excellent	Excellent	Excellent	Excellent
Alcohol	Good	Good	Good	Good	Good	Fair	Good
Acid	Fair	Poor	Poor	Poor	Poor	Poor	Excellent

Dimension

[Unit : mm]

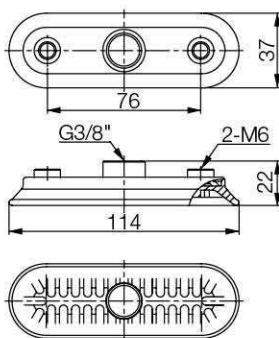

[With 38F fitting]

I Build an Ordering No.

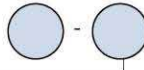
VOC35x110 -  : Pre-mounted fitting
1. Suction Cup

1. Suction cup	Description	Weight (g)	Symbol
	Oval-Curved suction cup, 35x110mm diameter, Nitrile (NBR), G3/8 female	56.26	VOC35x110-N-38F
	Oval-Curved suction cup, 35x110mm diameter, Silicone, G3/8 female	55.16	VOC35x110-S-38F
	Oval-Curved suction cup, 35x110mm diameter, White silicone, G3/8 female	54.74	VOC35x110-WS-38F
	Oval-Curved suction cup, 35x110mm diameter, White silicone (FDA), G3/8 female	54.74	VOC35x110-WS-38F (FDA)
	Oval-Curved suction cup, 35x110mm diameter, High temperature silicone, G3/8 female	55.36	VOC35x110-HS-38F
	Oval-Curved suction cup, 35x110mm diameter, Conductive silicone, G3/8 female	56.81	VOC35x110-CS-38F
	Oval-Curved suction cup, 35x110mm diameter, Urethane, G3/8 female	56.07	VOC35x110-U-38F
	Oval-Curved suction cup, 35x110mm diameter, Mark free, G3/8 female	58.78	VOC35x110-A-38F

SUCTION CUPS / Oval Curve

VOC60x140



Features and Strengths

Good for long objects with flat and curved surfaces
Strong lifting force and long life-span

Examples of use

Long flat objects, Curved surface, Metal panels, Automobile bumpers
Wood panel, Furniture

Recommended Lifting Force (Max.)

Model	Volume (cm ³)	Lifting Force (Kg) - Perpendicular			Lifting Force (Kg) - Parallel		
		- 20 kPa	- 60 kPa	- 90 kPa	- 20 kPa	- 60 kPa	- 90 kPa
VOC60x140	52.00	13.40	38.00	53.00	10.72	30.40	42.40

※ The lifting force above does not include safety factor

Material Specifications

Material	Hardness Shore (°)	Color	Temperature (°C)
NBR	60	Black	-20~110
Silicone	55	Red	-70~200
White Silicone	55	Translucent White	-70~200
White Silicone (FDA)	55	Translucent White	-70~200
High temp. Silicone	50	Blue	-70~280
Conductive Silicone	70	Smoky Black	-45~90
Urethane	60	Dark Green	0~100
Mark Free	75	Black	-10~100

Material Resistance

Description	NBR	Silicone	White Silicone	High temp. Silicone	Conductive Silicone	Urethane	Mark Free
Wear Resistance	Excellent	Good	Good	Good	Good	Excellent	Good
Oil	Excellent	Poor	Poor	Poor	Poor	Excellent	Excellent
Weather / Ozone	Fair	Excellent	Excellent	Excellent	Excellent	Excellent	Excellent
Alcohol	Good	Good	Good	Good	Good	Fair	Good
Acid	Fair	Poor	Poor	Poor	Poor	Poor	Excellent

Dimension

[Unit : mm]

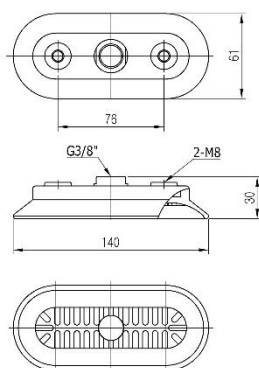

[With G3/8" fitting]

Build an Ordering No.

VOC60x140 -  : Pre-mounted fitting
1. Suction Cup

: Pre-mounted fitting

1. Suction cup	Description	Weight (g)	Symbol
	Oval-Curved suction cup, 60x140mm diameter, Nitrile (NBR), G3/8 female	148.54	VOC60x140-N-38F
	Oval-Curved suction cup, 60x140mm diameter, Silicone, G3/8 female	145.14	VOC60x140-S-38F
	Oval-Curved suction cup, 60x140mm diameter, White silicone, G3/8 female	145.34	VOC60x140-WS-38F
	Oval-Curved suction cup, 60x140mm diameter, White silicone (FDA), G3/8 female	145.34	VOC60x140-WS-38F (FDA)
	Oval-Curved suction cup, 60x140mm diameter, High temperature silicone, G3/8 female	149.02	VOC60x140-HS-38F
	Oval-Curved suction cup, 60x140mm diameter, Conductive silicone, G3/8 female	150.97	VOC60x140-CS-38F
	Oval-Curved suction cup, 60x140mm diameter, Urethane, G3/8 female	149.54	VOC60x140-U-38F
	Oval-Curved suction cup, 60x140mm diameter, Mark free, G3/8 female	155.48	VOC60x140-A-38F

SUCTION CUPS / Oval Curve

VOC60x180

Features and Strengths

Good for long objects with flat and curved surfaces
Strong lifting force and long life-span

Examples of use

Long flat objects, Curved surface, Metal panels, Automobile bumpers



Recommended Lifting Force (Max.)

Model	Volume (cm ³)	Lifting Force (Kg) - Perpendicular			Lifting Force (Kg) - Parallel		
		- 20 kPa	- 60 kPa	- 90 kPa	- 20 kPa	- 60 kPa	- 90 kPa
VOC60x180	67.00	19.10	54.20	75.70	15.28	43.36	60.56

※ The lifting force above does not include safety factor

Material Specifications

Material	Hardness Shore (°)	Color	Temperature (°C)
NBR	60	Black	-20~110
Silicone	55	Red	-70~200
White Silicone	55	Translucent White	-70~200
White Silicone (FDA)	55	Translucent White	-70~200
High temp. Silicone	50	Blue	-70~280
Conductive Silicone	70	Smoky Black	-45~90
Urethane	60	Dark Green	0~100
Mark Free	75	Black	-10~100

Material Resistance

Description	NBR	Silicone	White Silicone	High temp. Silicone	Conductive Silicone	Urethane	Mark Free
Wear Resistance	Excellent	Good	Good	Good	Good	Excellent	Good
Oil	Excellent	Poor	Poor	Poor	Poor	Excellent	Excellent
Weather / Ozone	Fair	Excellent	Excellent	Excellent	Excellent	Excellent	Excellent
Alcohol	Good	Good	Good	Good	Good	Fair	Good
Acid	Fair	Poor	Poor	Poor	Poor	Poor	Excellent

Dimension

[Unit : mm]

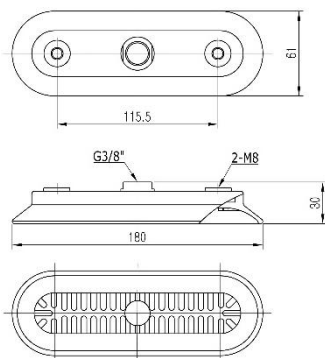

[With G3/8" fitting]

Build an Ordering No.

VOC60x180 -  : Pre-mounted fitting

1. Suction Cup

: Pre-mounted fitting

1. Suction cup	Description	Weight (g)	Symbol
	Oval-Curved suction cup, 60x180mm diameter, Nitrile (NBR), G3/8 female	213.43	VOC60x180-N-38F
	Oval-Curved suction cup, 60x180mm diameter, Silicone, G3/8 female	204.01	VOC60x180-S-38F
	Oval-Curved suction cup, 60x180mm diameter, White silicone, G3/8 female	204.56	VOC60x180-WS-38F
	Oval-Curved suction cup, 60x180mm diameter, White silicone (FDA), G3/8 female	204.56	VOC60x180-WS-38F (FDA)
	Oval-Curved suction cup, 60x180mm diameter, High temperature silicone, G3/8 female	204.96	VOC60x180-HS-38F
	Oval-Curved suction cup, 60x180mm diameter, Conductive silicone, G3/8 female	204.88	VOC60x180-CS-38F
	Oval-Curved suction cup, 60x180mm diameter, Urethane, G3/8 female	215.75	VOC60x180-U-38F
	Oval-Curved suction cup, 60x180mm diameter, Mark free, G3/8 female	143.11	VOC60x180-A-38F