

# SUCTION CUPS / Universal

## VU1.5X



### Features and Strengths

Excellent performance for flat stable and slightly curved surfaces with direct fitting  
Suitable for concave surface

### Examples of use

Small components, Semiconductor chips, Packaging materials,  
Metal sheet, Printing industry, Paper box

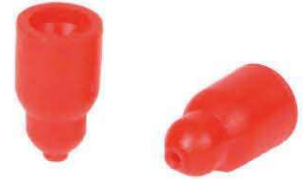

### Recommended Lifting Force (Max.)

Model	Volume (cm <sup>3</sup> )	Lifting Force (Kg) - Perpendicular		
		- 20 kPa	- 60 kPa	- 90 kPa
VU1.5X	0.0015	0.0008	0.003	0.004

※ The lifting force above does not include safety factor

### Material Specifications

Material	Hardness Shore (°)	Color	Temperature (°C)
NBR	60	Black	-20~110
Silicone	55	Red	-70~200
White Silicone	55	Translucent White	-70~200
White Silicone (FDA)	55	Translucent White	-70~200
High temp. Silicone	50	Blue	-70~280
Conductive Silicone	70	Smoky Black	-45~90
Urethane	60	Dark Green	0~100
Mark Free	75	Black	-10~100

※ For additional material, see page 32~33

### Material Resistance

Description	NBR	Silicone	White Silicone	High temp. Silicone	Conductive Silicone	Urethane	Mark Free
Wear Resistance	Excellent	Good	Good	Good	Good	Excellent	Good
Oil	Excellent	Poor	Poor	Poor	Poor	Excellent	Excellent
Weather / Ozone	Fair	Excellent	Excellent	Excellent	Excellent	Excellent	Excellent
Alcohol	Good	Good	Good	Good	Good	Fair	Good
Acid	Fair	Poor	Poor	Poor	Poor	Poor	Excellent

## I Build an Ordering No.

### VU1.5X -

1. Suction Cup

1. Suction cup	Description	Weight (g)	Symbol
	Universal suction cup, For level compensator mount, 1.5mm diameter, Nitrile (NBR)	0.26	VU1.5X-N
	Universal suction cup, For level compensator mount, 1.5mm diameter, Silicone	0.22	VU1.5X-S
	Universal suction cup, For level compensator mount, 1.5mm diameter, White silicone	0.24	VU1.5X-WS
	Universal suction cup, For level compensator mount, 1.5mm diameter, White silicone (FDA)	0.24	VU1.5X-WS(FDA)
	Universal suction cup, For level compensator mount, 1.5mm diameter, High temperature silicone	0.25	VU1.5X-HS
	Universal suction cup, For level compensator mount, 1.5mm diameter, Conductive silicone	0.25	VU1.5X-CS
	Universal suction cup, For level compensator mount, 1.5mm diameter, Urethane	0.26	VU1.5X-U
	Universal suction cup, For level compensator mount, 1.5mm diameter, Mark free	0.32	VU1.5X-A

[ Unit : mm ]

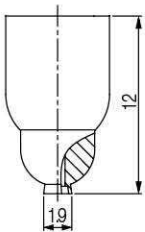

[ Rubber part ]

# SUCTION CUPS / Universal

## VU2

### Features and Strengths

Excellent performance for flat stable and slightly curved surfaces with direct fitting  
Suitable for concave surface

### Examples of use

Small components, Semiconductor chips, Packaging materials,  
Metal sheet, Printing industry, Paper box



### Recommended Lifting Force (Max.)

Model	Volume (cm <sup>3</sup> )	Lifting Force (Kg) - Perpendicular		
		- 20 kPa	- 60 kPa	- 90 kPa
VU2	0.0025	0.003	0.01	0.015

※ The lifting force above does not include safety factor

### Material Specifications

Material	Hardness Shore (°)	Color	Temperature (°C)
NBR	60	Black	-20~110
Silicone	55	Red	-70~200
White Silicone	55	Translucent White	-70~200
White Silicone (FDA)	55	Translucent White	-70~200
High temp. Silicone	50	Blue	-70~280
Conductive Silicone	70	Smoky Black	-45~90
Urethane	60	Dark Green	0~100
Mark Free	75	Black	-10~100

※ For additional material, see page 32~33

### Material Resistance

Description	NBR	Silicone	White Silicone	High temp. Silicone	Conductive Silicone	Urethane	Mark Free
Wear Resistance	Excellent	Good	Good	Good	Good	Excellent	Good
Oil	Excellent	Poor	Poor	Poor	Poor	Excellent	Excellent
Weather / Ozone	Fair	Excellent	Excellent	Excellent	Excellent	Excellent	Excellent
Alcohol	Good	Good	Good	Good	Good	Fair	Good
Acid	Fair	Poor	Poor	Poor	Poor	Poor	Excellent

### Dimension

[ Unit : mm ]

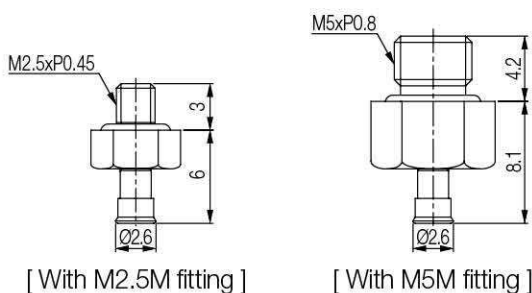

## I Build an Ordering No.

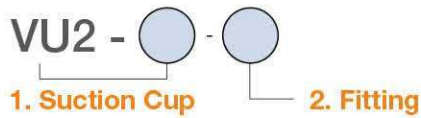

1. Suction cup	Description	Symbol
	Universal suction cup, 2mm diameter, Nitrile (NBR)	VU2-N
	Universal suction cup, 2mm diameter, Silicone	VU2-S
	Universal suction cup, 2mm diameter, White silicone	VU2-WS
	Universal suction cup, 2mm diameter, White silicone (FDA)	VU2-WS (FDA)
	Universal suction cup, 2mm diameter, High temperature silicone	VU2-HS
	Universal suction cup, 2mm diameter, Conductive silicone	VU2-CS
	Universal suction cup, 2mm diameter, Urethane	VU2-U
	Universal suction cup, 2mm diameter, Mark free	VU2-A

  

2. Fitting	Description	Symbol
	Fitting, M2.5 male	M2.5M
	Fitting, M5 male	M5M

## I Spare Parts – Rubber Parts

Part No.	Description	Weight (g)	Color
VU2-N	Universal suction cup, 2mm diameter, Nitrile (NBR)	0.01	Black
VU2-S	Universal suction cup, 2mm diameter, Silicone	0.01	Red
VU2-WS	Universal suction cup, 2mm diameter, White silicone	0.01	Translucent White
VU2-WS (FDA)	Universal suction cup, 2mm diameter, White silicone (FDA)	0.01	Translucent White
VU2-HS	Universal suction cup, 2mm diameter, High temperature silicone	0.01	Blue
VU2-CS	Universal suction cup, 2mm diameter, Conductive silicone	0.01	Smoky Black
VU2-U	Universal suction cup, 2mm diameter, Urethane	0.01	Dark Green
VU2-A	Universal suction cup, 2mm diameter, Mark free	0.01	Black

[ Unit : mm ]

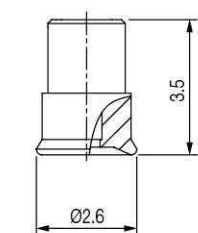

[ Rubber part ]

## I Spare Parts – Fittings

Part No. (Code No.)	Fitting size	Description	Weight (g)
350 000 3000	M2.5M	M2.5 male	0.47
350 000 3100	M5M	M5 male	0.54

# SUCTION CUPS / Universal

## VU2X

### Features and Strengths

Excellent performance for flat stable and slightly curved surfaces with direct fitting  
Suitable for concave surface

### Examples of use

Small components, Semiconductor chips, Packaging materials,  
Metal sheet, Printing industry, Paper box



### Recommended Lifting Force (Max.)

Model	Volume (cm <sup>3</sup> )	Lifting Force (Kg) - Perpendicular		
		- 20 kPa	- 60 kPa	- 90 kPa
VU2X	0.0025	0.003	0.01	0.015

※ The lifting force above does not include safety factor

### Material Specifications

Material	Hardness Shore (°)	Color	Temperature (°C)
NBR	60	Black	-20~110
Silicone	55	Red	-70~200
White Silicone	55	Translucent White	-70~200
White Silicone (FDA)	55	Translucent White	-70~200
High temp. Silicone	50	Blue	-70~280
Conductive Silicone	70	Smoky Black	-45~90
Urethane	60	Dark Green	0~100
Mark Free	75	Black	-10~100

※ For additional material, see page 32~33

### Material Resistance

Description	NBR	Silicone	White Silicone	High temp. Silicone	Conductive Silicone	Urethane	Mark Free
Wear Resistance	Excellent	Good	Good	Good	Good	Excellent	Good
Oil	Excellent	Poor	Poor	Poor	Poor	Excellent	Excellent
Weather / Ozone	Fair	Excellent	Excellent	Excellent	Excellent	Excellent	Excellent
Alcohol	Good	Good	Good	Good	Good	Fair	Good
Acid	Fair	Poor	Poor	Poor	Poor	Poor	Excellent

## I Build an Ordering No.

### VU2X -

1. Suction Cup

1. Suction cup	Description	Weight (g)	Symbol
	Universal suction cup, For level compensator mount, 2mm diameter, Nitrile (NBR)	0.33	VU2X-N
	Universal suction cup, For level compensator mount, 2mm diameter, Silicone	0.32	VU2X-S
	Universal suction cup, For level compensator mount, 2mm diameter, White silicone	0.30	VU2X-WS
	Universal suction cup, For level compensator mount, 2mm diameter, White silicone (FDA)	0.30	VU2X-WS(FDA)
	Universal suction cup, For level compensator mount, 2mm diameter, High temperature silicone	0.31	VU2X-HS
	Universal suction cup, For level compensator mount, 2mm diameter, Conductive silicone	0.31	VU2X-CS
	Universal suction cup, For level compensator mount, 2mm diameter, Urethane	0.34	VU2X-U
	Universal suction cup, For level compensator mount, 2mm diameter, Mark free	0.40	VU2X-A

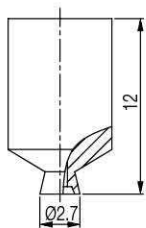

[ Rubber part ]

[ Unit : mm ]

# SUCTION CUPS / Universal

## VU3

### Features and Strengths

Excellent performance for flat stable and slightly curved surfaces with direct fitting  
Suitable for concave surface

### Examples of use

Small components, Semiconductor chips, Packaging materials,  
Metal sheet, Printing industry, Paper box



### Recommended Lifting Force (Max.)

Model	Volume (cm <sup>3</sup> )	Lifting Force (Kg) - Perpendicular		
		- 20 kPa	- 60 kPa	- 90 kPa
VU3	0.005	0.009	0.04	0.06

※ The lifting force above does not include safety factor

### Material Specifications

Material	Hardness Shore (°)	Color	Temperature (°C)
NBR	60	Black	-20~110
Silicone	55	Red	-70~200
White Silicone	55	Translucent White	-70~200
White Silicone (FDA)	55	Translucent White	-70~200
High temp. Silicone	50	Blue	-70~280
Conductive Silicone	70	Smoky Black	-45~90
Urethane	60	Dark Green	0~100
Mark Free	75	Black	-10~100

※ For additional material, see page 32~33

### Material Resistance

Description	NBR	Silicone	White Silicone	High temp. Silicone	Conductive Silicone	Urethane	Mark Free
Wear Resistance	Excellent	Good	Good	Good	Good	Excellent	Good
Oil	Excellent	Poor	Poor	Poor	Poor	Excellent	Excellent
Weather / Ozone	Fair	Excellent	Excellent	Excellent	Excellent	Excellent	Excellent
Alcohol	Good	Good	Good	Good	Good	Fair	Good
Acid	Fair	Poor	Poor	Poor	Poor	Poor	Excellent

### Dimension

[ Unit : mm ]

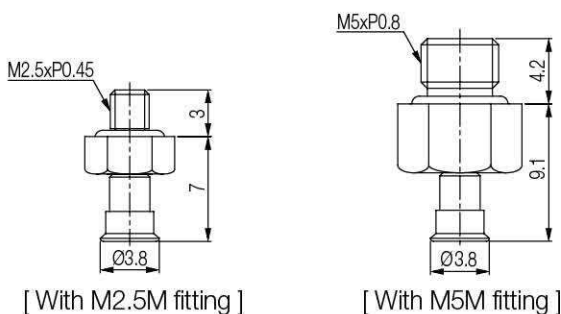

## I Build an Ordering No.

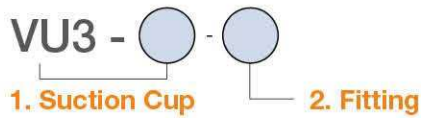

1. Suction cup	Description	Symbol
	Universal suction cup, 3mm diameter, Nitrile (NBR)	VU3-N
	Universal suction cup, 3mm diameter, Silicone	VU3-S
	Universal suction cup, 3mm diameter, White silicone	VU3-WS
	Universal suction cup, 3mm diameter, White silicone (FDA)	VU3-WS (FDA)
	Universal suction cup, 3mm diameter, High temperature silicone	VU3-HS
	Universal suction cup, 3mm diameter, Conductive silicone	VU3-CS
	Universal suction cup, 3mm diameter, Urethane	VU3-U
	Universal suction cup, 3mm diameter, Mark free	VU3-A

  

2. Fitting	Description	Symbol
	Fitting, M2.5 male	M2.5M
	Fitting, M5 male	M5M

## I Spare Parts – Rubber Parts

Part No.	Description	Weight (g)	Color
VU3-N	Universal suction cup, 3mm diameter, Nitrile (NBR)	0.01	Black
VU3-S	Universal suction cup, 3mm diameter, Silicone	0.01	Red
VU3-WS	Universal suction cup, 3mm diameter, White silicone	0.01	Translucent White
VU3-WS (FDA)	Universal suction cup, 3mm diameter, White silicone (FDA)	0.01	Translucent White
VU3-HS	Universal suction cup, 3mm diameter, High temperature silicone	0.01	Blue
VU3-CS	Universal suction cup, 3mm diameter, Conductive silicone	0.01	Smoky Black
VU3-U	Universal suction cup, 3mm diameter, Urethane	0.01	Dark Green
VU3-A	Universal suction cup, 3mm diameter, Mark free	0.01	Black

[ Unit : mm ]

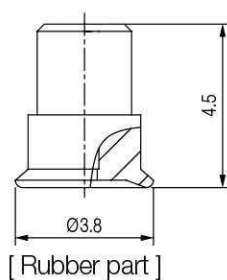

## I Spare Parts – Fittings

Part No. (Code No.)	Fitting size	Description	Weight (g)
350 000 3000	M2.5M	M2.5 male	0.47
350 000 3100	M5M	M5 male	0.54

# SUCTION CUPS / Universal

## VU3K

### Features and Strengths

Excellent performance for flat stable and slightly curved surfaces  
Suitable for concave surface

### Examples of use

Small components, Semiconductor chips, Packaging materials,  
Metal sheet, Printing industry, Paper box



### Recommended Lifting Force (Max.)

Model	Volume (cm <sup>3</sup> )	Lifting Force (Kg) - Perpendicular		
		- 20 kPa	- 60 kPa	- 90 kPa
VU3K	0.018	0.014	0.06	0.09

※ The lifting force above does not include safety factor

### Material Specifications

Material	Hardness Shore (°)	Color	Temperature (°C)
NBR	60	Black	-20~110
Silicone	55	Red	-70~200
White Silicone	55	Translucent White	-70~200
White Silicone (FDA)	55	Translucent White	-70~200
High temp. Silicone	50	Blue	-70~280
Conductive Silicone	70	Smoky Black	-45~90
Urethane	60	Dark Green	0~100
Mark Free	75	Black	-10~100

※ For additional material, see page 32~33

### Material Resistance

Description	NBR	Silicone	White Silicone	High temp. Silicone	Conductive Silicone	Urethane	Mark Free
Wear Resistance	Excellent	Good	Good	Good	Good	Excellent	Good
Oil	Excellent	Poor	Poor	Poor	Poor	Excellent	Excellent
Weather / Ozone	Fair	Excellent	Excellent	Excellent	Excellent	Excellent	Excellent
Alcohol	Good	Good	Good	Good	Good	Fair	Good
Acid	Fair	Poor	Poor	Poor	Poor	Poor	Excellent

### Dimension

[ Unit : mm ]

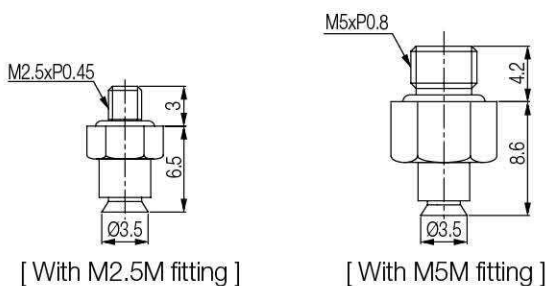

## I Build an Ordering No.

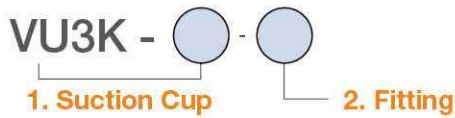

1. Suction cup	Description	Symbol
	Universal suction cup, For level compensator mount, 3mm diameter, Nitrile (NBR)	VU3K-N
	Universal suction cup, For level compensator mount, 3mm diameter, Silicone	VU3K-S
	Universal suction cup, For level compensator mount, 3mm diameter, White silicone	VU3K-WS
	Universal suction cup, For level compensator mount, 3mm diameter, White silicone(FDA)	VU3K-WS(FDA)
	Universal suction cup, For level compensator mount, 3mm diameter, High temperature silicone	VU3K-HS
	Universal suction cup, For level compensator mount, 3mm diameter, Conductive silicone	VU3K-CS
	Universal suction cup, For level compensator mount, 3mm diameter, Urethane	VU3K-U
	Universal suction cup, For level compensator mount, 3mm diameter, Mark free	VU3K-A

  

2. Fitting	Description	Symbol
	Fitting, M2.5 male	M2.5M
	Fitting, M5 male	M5M

## I Spare Parts – Rubber Parts

Part No.	Description	Weight (g)	Color
VU3K-N	Universal suction cup, For level compensator mount, 3mm diameter, Nitrile (NBR)	0.01	Black
VU3K-S	Universal suction cup, For level compensator mount, 3mm diameter, Silicone	0.01	Red
VU3K-WS	Universal suction cup, For level compensator mount, 3mm diameter, White silicone	0.01	Translucent White
VU3K-WS(FDA)	Universal suction cup, For level compensator mount, 3mm diameter, White silicone(FDA)	0.01	Translucent White
VU3K-HS	Universal suction cup, For level compensator mount, 3mm diameter, High temperature silicone	0.01	Blue
VU3K-CS	Universal suction cup, For level compensator mount, 3mm diameter, Conductive silicone	0.01	Smoky Black
VU3K-U	Universal suction cup, For level compensator mount, 3mm diameter, Urethane	0.01	Dark Green
VU3K-A	Universal suction cup, For level compensator mount, 3mm diameter, Mark free	0.01	Black

[ Unit : mm ]

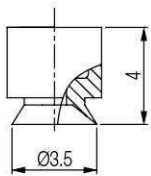

[ Rubber part ]

## I Spare Parts – Fittings

Part No. (Code No.)	Fitting size	Description	Weight (g)
350 000 3006	M2.5M	M2.5 male	2.03
350 000 3106	M5M	M5 male	1.93

# SUCTION CUPS / Universal

## VU4

### Features and Strengths

Excellent performance for flat stable and slightly curved surfaces  
Suitable for concave surface

### Examples of use

Small components, Semiconductor chips, Packaging materials,  
Metal sheet, Printing industry, Paper box



### Recommended Lifting Force (Max.)

Model	Volume (cm <sup>3</sup> )	Lifting Force (Kg) - Perpendicular			Lifting Force (Kg) - Parallel		
		- 20 kPa	- 60 kPa	- 90 kPa	- 20 kPa	- 60 kPa	- 90 kPa
VU4	0.03	0.02	0.09	0.13	0.02	0.08	0.10

※ The lifting force above does not include safety factor

### Material Specifications

Material	Hardness Shore (°)	Color	Temperature (°C)
NBR	60	Black	-20~110
Silicone	55	Red	-70~200
White Silicone	55	Translucent White	-70~200
White Silicone (FDA)	55	Translucent White	-70~200
High temp. Silicone	50	Blue	-70~280
Conductive Silicone	70	Smoky Black	-45~90
Urethane	60	Dark Green	0~100
Mark Free	75	Black	-10~100

※ For additional material, see page 32~33

### Material Resistance

Description	NBR	Silicone	White Silicone	High temp. Silicone	Conductive Silicone	Urethane	Mark Free
Wear Resistance	Excellent	Good	Good	Good	Good	Excellent	Good
Oil	Excellent	Poor	Poor	Poor	Poor	Excellent	Excellent
Weather / Ozone	Fair	Excellent	Excellent	Excellent	Excellent	Excellent	Excellent
Alcohol	Good	Good	Good	Good	Good	Fair	Good
Acid	Fair	Poor	Poor	Poor	Poor	Poor	Excellent

### Dimension

[ Unit : mm ]

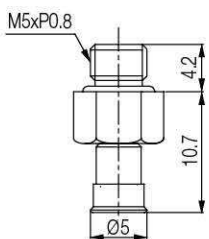

[ With M5M fitting ]

## I Build an Ordering No.

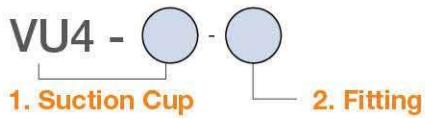

1. Suction cup	Description	Symbol
	Universal suction cup, 4mm diameter, Nitrile (NBR)	VU4-N
	Universal suction cup, 4mm diameter, Silicone	VU4-S
	Universal suction cup, 4mm diameter, White silicone	VU4-WS
	Universal suction cup, 4mm diameter, White silicone(FDA)	VU4-WS(FDA)
	Universal suction cup, 4mm diameter, High temperature silicone	VU4-HS
	Universal suction cup, 4mm diameter, Conductive silicone	VU4-CS
	Universal suction cup, 4mm diameter, Urethane	VU4-U
	Universal suction cup, 4mm diameter, Mark free	VU4-A
2. Fitting	Description	Symbol
	Fitting, M5 male	M5M

## I Spare Parts – Rubber Parts

Part No.	Description	Weight (g)	Color
VU4-N	Universal suction cup, 4mm diameter, Nitrile (NBR)	0.07	Black
VU4-S	Universal suction cup, 4mm diameter, Silicone	0.07	Red
VU4-WS	Universal suction cup, 4mm diameter, White silicone	0.07	Translucent White
VU4-WS (FDA)	Universal suction cup, 4mm diameter, White silicone(FDA)	0.07	Translucent White
VU4-HS	Universal suction cup, 4mm diameter, High temperature silicone	0.07	Blue
VU4-CS	Universal suction cup, 4mm diameter, Conductive silicone	0.06	Smoky Black
VU4-U	Universal suction cup, 4mm diameter, Urethane	0.06	Dark Green
VU4-A	Universal suction cup, 4mm diameter, Mark free	0.08	Black

[ Unit : mm ]

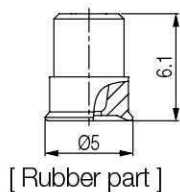

## I Spare Parts – Fittings

Part No. (Code No.)	Fitting size	Description	Weight (g)
350 000 3101	M5M	M5 male	1.84

# SUCTION CUPS / Universal

## VU4X



### Features and Strengths

Excellent performance for flat stable and slightly curved surfaces with direct fitting  
Suitable for concave surface

### Examples of use

Small components, Semiconductor chips, Packaging materials,  
Metal sheet, Printing industry, Paper box



### Recommended Lifting Force (Max.)

Model	Volume (cm <sup>3</sup> )	Lifting Force (Kg) - Perpendicular			Lifting Force (Kg) - Parallel		
		- 20 kPa	- 60 kPa	- 90 kPa	- 20 kPa	- 60 kPa	- 90 kPa
VU4X	0.03	0.02	0.09	0.13	0.02	0.08	0.10

※ The lifting force above does not include safety factor

### Material Specifications

Material	Hardness Shore (°)	Color	Temperature (°C)
NBR	60	Black	-20~110
Silicone	55	Red	-70~200
White Silicone	55	Translucent White	-70~200
White Silicone (FDA)	55	Translucent White	-70~200
High temp. Silicone	50	Blue	-70~280
Conductive Silicone	70	Smoky Black	-45~90
Urethane	60	Dark Green	0~100
Mark Free	75	Black	-10~100

※ For additional material, see page 32~33

### Material Resistance

Description	NBR	Silicone	White Silicone	High temp. Silicone	Conductive Silicone	Urethane	Mark Free
Wear Resistance	Excellent	Good	Good	Good	Good	Excellent	Good
Oil	Excellent	Poor	Poor	Poor	Poor	Excellent	Excellent
Weather / Ozone	Fair	Excellent	Excellent	Excellent	Excellent	Excellent	Excellent
Alcohol	Good	Good	Good	Good	Good	Fair	Good
Acid	Fair	Poor	Poor	Poor	Poor	Poor	Excellent

## I Build an Ordering No.

### VU4X -

1. Suction Cup

1. Suction cup	Description	Weight (g)	Symbol
	Universal suction cup, For level compensator mount, 4mm diameter, Nitrile (NBR)	0.32	VU4X-N
	Universal suction cup, For level compensator mount, 4mm diameter, Silicone	0.30	VU4X-S
	Universal suction cup, For level compensator mount, 4mm diameter, White silicone	0.29	VU4X-WS
	Universal suction cup, For level compensator mount, 4mm diameter, White silicone(FDA)	0.29	VU4X-WS(FDA)
	Universal suction cup, For level compensator mount, 4mm diameter, High temperature silicone	0.31	VU4X-HS
	Universal suction cup, For level compensator mount, 4mm diameter, Conductive silicone	0.31	VU4X-CS
	Universal suction cup, For level compensator mount, 4mm diameter, Urethane	0.33	VU4X-U
	Universal suction cup, For level compensator mount, 4mm diameter, Mark free	0.38	VU4X-A

[ Unit : mm ]

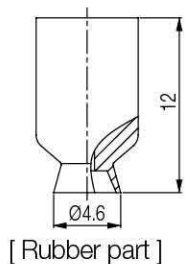

# SUCTION CUPS / Universal

## VU6

### Features and Strengths

Excellent performance for flat stable and slightly curved surfaces  
Suitable for concave surface

### Examples of use

Small components, Semiconductor chips, Packaging materials,  
Metal sheet, Printing industry, Paper box



### Recommended Lifting Force (Max.)

Model	Volume (cm <sup>3</sup> )	Lifting Force (Kg) - Perpendicular			Lifting Force (Kg) - Parallel		
		- 20 kPa	- 60 kPa	- 90 kPa	- 20 kPa	- 60 kPa	- 90 kPa
VU6	0.05	0.05	0.17	0.25	0.03	0.15	0.20

※ The lifting force above does not include safety factor

### Material Specifications

Material	Hardness Shore (°)	Color	Temperature (°C)
NBR	60	Black	-20~110
Silicone	55	Red	-70~200
White Silicone	55	Translucent White	-70~200
White Silicone (FDA)	55	Translucent White	-70~200
High temp. Silicone	50	Blue	-70~280
Conductive Silicone	70	Smoky Black	-45~90
Urethane	60	Dark Green	0~100
Mark Free	75	Black	-10~100

※ For additional material, see page 32~33

### Material Resistance

Description	NBR	Silicone	White Silicone	High temp. Silicone	Conductive Silicone	Urethane	Mark Free
Wear Resistance	Excellent	Good	Good	Good	Good	Excellent	Good
Oil	Excellent	Poor	Poor	Poor	Poor	Excellent	Excellent
Weather / Ozone	Fair	Excellent	Excellent	Excellent	Excellent	Excellent	Excellent
Alcohol	Good	Good	Good	Good	Good	Fair	Good
Acid	Fair	Poor	Poor	Poor	Poor	Poor	Excellent

### Dimension

[ Unit : mm ]

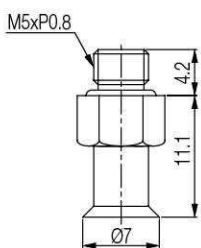

[ With M5M fitting ]

## Build an Ordering No.

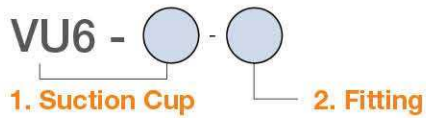

1. Suction cup	Description	Symbol
	Universal suction cup, 6mm diameter, Nitrile (NBR)	VU6-N
	Universal suction cup, 6mm diameter, Silicone	VU6-S
	Universal suction cup, 6mm diameter, White silicone	VU6-WS
	Universal suction cup, 6mm diameter, White silicone(FDA)	VU6-WS(FDA)
	Universal suction cup, 6mm diameter, High temperature silicone	VU6-HS
	Universal suction cup, 6mm diameter, Conductive silicone	VU6-CS
	Universal suction cup, 6mm diameter, Urethane	VU6-U
	Universal suction cup, 6mm diameter, Mark free	VU6-A
2. Fitting	Description	Symbol
	Fitting, M5 male	M5M

## Spare Parts – Rubber Parts

Part No.	Description	Weight (g)	Color
VU6-N	Universal suction cup, 6mm diameter, Nitrile (NBR)	0.13	Black
VU6-S	Universal suction cup, 6mm diameter, Silicone	0.12	Red
VU6-WS	Universal suction cup, 6mm diameter, White silicone	0.11	Translucent White
VU6-WS (FDA)	Universal suction cup, 6mm diameter, White silicone(FDA)	0.11	Translucent White
VU6-HS	Universal suction cup, 6mm diameter, High temperature silicone	0.11	Blue
VU6-CS	Universal suction cup, 6mm diameter, Conductive silicone	0.12	Smoky Black
VU6-U	Universal suction cup, 6mm diameter, Urethane	0.13	Dark Green
VU6-A	Universal suction cup, 6mm diameter, Mark free	0.14	Black

[ Unit : mm ]

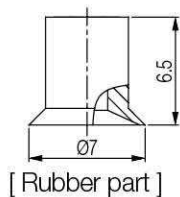

## Spare Parts – Fittings

Part No. (Code No.)	Fitting size	Description	Weight (g)
350 000 3101	M5M	M5 male	1.84

# SUCTION CUPS / Universal

## VU8

### Features and Strengths

Excellent performance for flat stable and slightly curved surfaces  
Suitable for concave surface

### Examples of use

Small components, Semiconductor chips, Packaging materials,  
Metal sheet, Printing industry, Paper box



### Recommended Lifting Force (Max.)

Model	Volume (cm <sup>3</sup> )	Lifting Force (Kg) - Perpendicular			Lifting Force (Kg) - Parallel		
		- 20 kPa	- 60 kPa	- 90 kPa	- 20 kPa	- 60 kPa	- 90 kPa
VU8	0.10	0.10	0.29	0.39	0.10	0.29	0.34

※ The lifting force above does not include safety factor

### Material Specifications

Material	Hardness Shore (°)	Color	Temperature (°C)
NBR	60	Black	-20~110
Silicone	55	Red	-70~200
White Silicone	55	Translucent White	-70~200
White Silicone (FDA)	55	Translucent White	-70~200
High temp. Silicone	50	Blue	-70~280
Conductive Silicone	70	Smoky Black	-45~90
Urethane	60	Dark Green	0~100
Mark Free	75	Black	-10~100

※ For additional material, see page 32~33

### Material Resistance

Description	NBR	Silicone	White Silicone	High temp. Silicone	Conductive Silicone	Urethane	Mark Free
Wear Resistance	Excellent	Good	Good	Good	Good	Excellent	Good
Oil	Excellent	Poor	Poor	Poor	Poor	Excellent	Excellent
Weather / Ozone	Fair	Excellent	Excellent	Excellent	Excellent	Excellent	Excellent
Alcohol	Good	Good	Good	Good	Good	Fair	Good
Acid	Fair	Poor	Poor	Poor	Poor	Poor	Excellent

### Dimension

[ Unit : mm ]

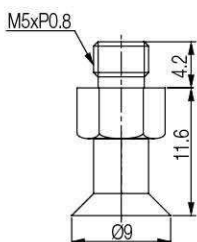

[ With M5M fitting ]

## I Build an Ordering No.

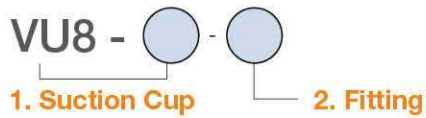

1. Suction cup	Description	Symbol
	Universal suction cup, 8mm diameter, Nitrile (NBR)	VU8-N
	Universal suction cup, 8mm diameter, Silicone	VU8-S
	Universal suction cup, 8mm diameter, White silicone	VU8-WS
	Universal suction cup, 8mm diameter, White silicone(FDA)	VU8-WS(FDA)
	Universal suction cup, 8mm diameter, High temperature silicone	VU8-HS
	Universal suction cup, 8mm diameter, Conductive silicone	VU8-CS
	Universal suction cup, 8mm diameter, Urethane	VU8-U
	Universal suction cup, 8mm diameter, Mark free	VU8-A
2. Fitting	Description	Symbol
	Fitting, M5 male	M5M

## I Spare Parts – Rubber Parts

Part No.	Description	Weight (g)	Color
VU8-N	Universal suction cup, 8mm diameter, Nitrile (NBR)	0.18	Black
VU8-S	Universal suction cup, 8mm diameter, Silicone	0.16	Red
VU8-WS	Universal suction cup, 8mm diameter, White silicone	0.15	Translucent White
VU8-WS (FDA)	Universal suction cup, 8mm diameter, White silicone(FDA)	0.15	Translucent White
VU8-HS	Universal suction cup, 8mm diameter, High temperature silicone	0.15	Blue
VU8-CS	Universal suction cup, 8mm diameter, Conductive silicone	0.18	Smoky Black
VU8-U	Universal suction cup, 8mm diameter, Urethane	0.17	Dark Green
VU8-A	Universal suction cup, 8mm diameter, Mark free	0.18	Black

[ Unit : mm ]

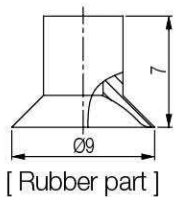

## I Spare Parts – Fittings

Part No. (Code No.)	Fitting size	Description	Weight (g)
350 000 3101	M5M	M5 male	1.84

# SUCTION CUPS / Universal

## VU10

### Features and Strengths

Excellent performance for flat stable and slightly curved surfaces  
Suitable for concave surface

### Examples of use

Semiconductor chips, Packaging materials, Metal sheet,  
Printing industry, Paper box



### Recommended Lifting Force (Max.)

Model	Volume (cm <sup>3</sup> )	Lifting Force (Kg) - Perpendicular			Lifting Force (Kg) - Parallel		
		- 20 kPa	- 60 kPa	- 90 kPa	- 20 kPa	- 60 kPa	- 90 kPa
VU10	0.18	0.15	0.44	0.70	0.15	0.44	0.50

※ The lifting force above does not include safety factor

### Material Specifications

Material	Hardness Shore (°)	Color	Temperature (°C)
NBR	60	Black	-20~110
Silicone	55	Red	-70~200
White Silicone	55	Translucent White	-70~200
White Silicone (FDA)	55	Translucent White	-70~200
High temp. Silicone	50	Blue	-70~280
Conductive Silicone	70	Smoky Black	-45~90
Urethane	60	Dark Green	0~100
Mark Free	75	Black	-10~100

※ For additional material, see page 32~33

### Material Resistance

Description	NBR	Silicone	White Silicone	High temp. Silicone	Conductive Silicone	Urethane	Mark Free
Wear Resistance	Excellent	Good	Good	Good	Good	Excellent	Good
Oil	Excellent	Poor	Poor	Poor	Poor	Excellent	Excellent
Weather / Ozone	Fair	Excellent	Excellent	Excellent	Excellent	Excellent	Excellent
Alcohol	Good	Good	Good	Good	Good	Fair	Good
Acid	Fair	Poor	Poor	Poor	Poor	Poor	Excellent

### Dimension

[ Unit : mm ]

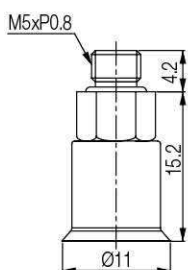

[ With M5M fitting ]

## I Build an Ordering No.

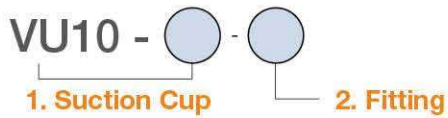

1. Suction cup	Description	Symbol
	Universal suction cup, 10mm diameter, Nitrile (NBR)	VU10-N
	Universal suction cup, 10mm diameter, Silicone	VU10-S
	Universal suction cup, 10mm diameter, White silicone	VU10-WS
	Universal suction cup, 10mm diameter, White silicone (FDA)	VU10-WS (FDA)
	Universal suction cup, 10mm diameter, High temperature silicone	VU10-HS
	Universal suction cup, 10mm diameter, Conductive silicone	VU10-CS
	Universal suction cup, 10mm diameter, Urethane	VU10-U
	Universal suction cup, 10mm diameter, Mark free	VU10-A
2. Fitting	Description	Symbol
	Fitting, M5 male	M5M
	Efficiency valve, Fitting, M5 male	M5M-EV

## I Spare Parts – Rubber Parts

Part No.	Description	Weight (g)	Color
VU10-N	Universal suction cup, 10mm diameter, Nitrile (NBR)	0.60	Black
VU10-S	Universal suction cup, 10mm diameter, Silicone	0.54	Red
VU10-WS	Universal suction cup, 10mm diameter, White silicone	0.53	Translucent White
VU10-WS (FDA)	Universal suction cup, 10mm diameter, White silicone (FDA)	0.53	Translucent White
VU10-HS	Universal suction cup, 10mm diameter, High temperature silicone	0.55	Blue
VU10-CS	Universal suction cup, 10mm diameter, Conductive silicone	0.51	Smoky Black
VU10-U	Universal suction cup, 10mm diameter, Urethane	0.60	Dark Green
VU10-A	Universal suction cup, 10mm diameter, Mark free	0.71	Black

[ Unit : mm ]

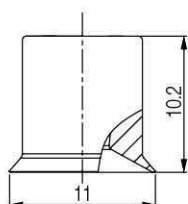

[ Rubber part ]

## I Spare Parts – Fittings

Part No. (Code No.)	Fitting size	Description	Weight (g)
350 000 3102	M5M	M5 male	2.52
350 010 3102	M5M-EV	Efficiency valve, M5 male	2.63

# SUCTION CUPS / Universal

## VU15

### Features and Strengths

Excellent performance for flat stable and slightly curved surfaces  
Suitable for concave surface

### Examples of use

Semiconductor chips, Packaging materials, Metal sheet,  
Printing industry, Paper box



### Recommended Lifting Force (Max.)

Model	Volume (cm <sup>3</sup> )	Lifting Force (Kg) - Perpendicular			Lifting Force (Kg) - Parallel		
		- 20 kPa	- 60 kPa	- 90 kPa	- 20 kPa	- 60 kPa	- 90 kPa
VU15	0.50	0.35	0.85	1.12	0.35	0.55	0.60

※ The lifting force above does not include safety factor

### Material Specifications

Material	Hardness Shore (°)	Color	Temperature (°C)
NBR	60	Black	-20~110
Silicone	55	Red	-70~200
White Silicone	55	Translucent White	-70~200
White Silicone (FDA)	55	Translucent White	-70~200
High temp. Silicone	50	Blue	-70~280
Conductive Silicone	70	Smoky Black	-45~90
Urethane	60	Dark Green	0~100
Mark Free	75	Black	-10~100

※ For additional material, see page 32~33

### Material Resistance

Description	NBR	Silicone	White Silicone	High temp. Silicone	Conductive Silicone	Urethane	Mark Free
Wear Resistance	Excellent	Good	Good	Good	Good	Excellent	Good
Oil	Excellent	Poor	Poor	Poor	Poor	Excellent	Excellent
Weather / Ozone	Fair	Excellent	Excellent	Excellent	Excellent	Excellent	Excellent
Alcohol	Good	Good	Good	Good	Good	Fair	Good
Acid	Fair	Poor	Poor	Poor	Poor	Poor	Excellent

### Dimension

[ Unit : mm ]

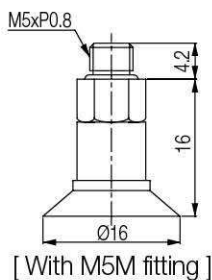

## Build an Ordering No.

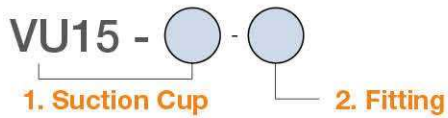

1. Suction cup	Description	Symbol
	Universal suction cup, 15mm diameter, Nitrile (NBR)	VU15-N
	Universal suction cup, 15mm diameter, Silicone	VU15-S
	Universal suction cup, 15mm diameter, White silicone	VU15-WS
	Universal suction cup, 15mm diameter, White silicone (FDA)	VU15-WS (FDA)
	Universal suction cup, 15mm diameter, High temperature silicone	VU15-HS
	Universal suction cup, 15mm diameter, Conductive silicone	VU15-CS
	Universal suction cup, 15mm diameter, Urethane	VU15-U
	Universal suction cup, 15mm diameter, Mark free	VU15-A

  

2. Fitting	Description	Symbol
	Fitting, M5 male	M5M
	Efficiency valve, Fitting, M5 male	M5M-EV

## Spare Parts – Rubber Parts

Part No.	Description	Weight (g)	Color
VU15-N	Universal suction cup, 15mm diameter, Nitrile (NBR)	0.75	Black
VU15-S	Universal suction cup, 15mm diameter, Silicone	0.66	Red
VU15-WS	Universal suction cup, 15mm diameter, White silicone	0.84	Translucent White
VU15-WS (FDA)	Universal suction cup, 15mm diameter, White silicone (FDA)	0.84	Translucent White
VU15-HS	Universal suction cup, 15mm diameter, High temperature silicone	0.65	Blue
VU15-CS	Universal suction cup, 15mm diameter, Conductive silicone	0.68	Smoky Black
VU15-U	Universal suction cup, 15mm diameter, Urethane	0.68	Dark Green
VU15-A	Universal suction cup, 15mm diameter, Mark free	1.03	Black

[ Unit : mm ]

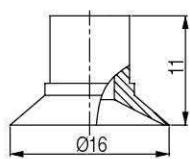

[ Rubber part ]

## Spare Parts – Fittings

Part No. (Code No.)	Fitting size	Description	Weight (g)
350 000 3102	M5M	M5 male	2.52
350 010 3102	M5M-EV	Efficiency valve, M5 male	2.63

# SUCTION CUPS / Universal

## VU20



### Features and Strengths

Excellent performance for flat stable and slightly curved surfaces  
Suitable for concave surface

### Examples of use

Semiconductor chips, Packaging materials, Metal sheet,  
Printing industry, Paper box



### Recommended Lifting Force (Max.)

Model	Volume (cm <sup>3</sup> )	Lifting Force (Kg) - Perpendicular			Lifting Force (Kg) - Parallel		
		- 20 kPa	- 60 kPa	- 90 kPa	- 20 kPa	- 60 kPa	- 90 kPa
VU20	1.00	0.60	1.22	1.63	0.60	0.89	1.00

※ The lifting force above does not include safety factor

### Material Specifications

Material	Hardness Shore (°)	Color	Temperature (°C)
NBR	60	Black	-20~110
Silicone	55	Red	-70~200
White Silicone	55	Translucent White	-70~200
White Silicone (FDA)	55	Translucent White	-70~200
High temp. Silicone	50	Blue	-70~280
Conductive Silicone	70	Smoky Black	-45~90
Urethane	60	Dark Green	0~100
Mark Free	75	Black	-10~100

※ For additional material, see page 32~33

### Material Resistance

Description	NBR	Silicone	White Silicone	High temp. Silicone	Conductive Silicone	Urethane	Mark Free
Wear Resistance	Excellent	Good	Good	Good	Good	Excellent	Good
Oil	Excellent	Poor	Poor	Poor	Poor	Excellent	Excellent
Weather / Ozone	Fair	Excellent	Excellent	Excellent	Excellent	Excellent	Excellent
Alcohol	Good	Good	Good	Good	Good	Fair	Good
Acid	Fair	Poor	Poor	Poor	Poor	Poor	Excellent

### Dimension

[ Unit : mm ]

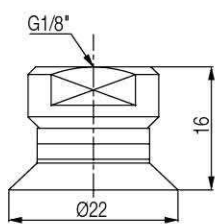

[ With 18F fitting ]

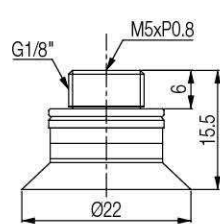

[ With M518MF fitting ]

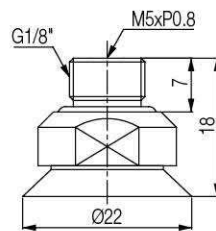

[ With M518MFX fitting ]

## I Build an Ordering No.

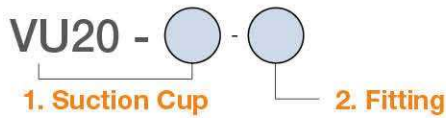

1. Suction cup	Description	Symbol
	Universal suction cup, 20mm diameter, Nitrile (NBR)	VU20-N
	Universal suction cup, 20mm diameter, Silicone	VU20-S
	Universal suction cup, 20mm diameter, White silicone	VU20-WS
	Universal suction cup, 20mm diameter, White silicone (FDA)	VU20-WS (FDA)
	Universal suction cup, 20mm diameter, High temperature silicone	VU20-HS
	Universal suction cup, 20mm diameter, Conductive silicone	VU20-CS
	Universal suction cup, 20mm diameter, Urethane	VU20-U
	Universal suction cup, 20mm diameter, Mark free	VU20-A

2. Fitting	Description	Symbol
	Fitting, G1/8 Male - M5 female	M518MF
	Fitting, G1/8 Male - M5 female, Mesh filter	M-M518MF
	Efficiency valve, Fitting, G1/8Male - M5 Female	M518MF-EV
	Fitting, G1/8 Male - M5 female, Old profile	M518MFO
	Fitting, G1/8 Male - M5 Female, Old profile, Mesh filter	M-M518MFO
	Efficiency valve, Fitting, G1/8Male - M5 Female, Old profile	M518MFO-EV
	Fitting, G1/8 male - M5 female, For silicone material	M518MFX*
	Fitting, G1/8 female	18F
	Fitting, G1/8 female, Mesh filter	M-18F
	Efficiency valve, Fitting, G1/8 Female	18F-EV

\* M518MFX is available only for Silicone material.

## I Spare Parts – Rubber Parts

Part No.	Description	Weight (g)	Color
VU20-N	Universal suction cup, 20mm diameter, Nitrile (NBR)	1.21	Black
VU20-S	Universal suction cup, 20mm diameter, Silicone	1.20	Red
VU20-WS	Universal suction cup, 20mm diameter, White silicone	1.20	Translucent White
VU20-WS (FDA)	Universal suction cup, 20mm diameter, White silicone (FDA)	1.20	Translucent White
VU20-HS	Universal suction cup, 20mm diameter, High temperature silicone	1.20	Blue
VU20-CS	Universal suction cup, 20mm diameter, Conductive silicone	1.26	Smoky Black
VU20-U	Universal suction cup, 20mm diameter, Urethane	1.22	Dark Green
VU20-A	Universal suction cup, 20mm diameter, Mark free	1.51	Black

[ Unit : mm ]

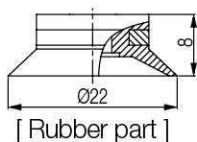

## I Spare Parts – Fittings

Part No. (Code No.)	Fitting size	Description	Weight (g)
350 000 3209	M518MF	G1/8 Male - M5 female	1.82
350 000 5209	M518MF-F	G1/8 Male - M5 female, Mesh filter	1.92
350 010 4209	M518MF-EV	Efficiency valve, G1/8Male - M5 Female	1.94
350 000 1209	M518MFO	G1/8 Male - M5 female, Old profile	2.88
350 000 1109	M518MFO-F	G1/8 Male - M5 Female, Old profile, Mesh filter	2.94
350 010 1209	M518MFO-EV	Efficiency valve, G1/8Male - M5 Female, Old profile	2.87
350 000 3229	M518MFX	G1/8 male - M5 female, For silicone material	3.71
350 000 3310	18F	G1/8 female	3.23
350 000 4310	18F-F	G1/8 female, Mesh filter	3.3
350 010 3310	18F-EV	Efficiency valve, G1/8 female	3.43

# SUCTION CUPS / Universal

## VU25

### Features and Strengths

Excellent performance for flat stable and slightly curved surfaces  
Suitable for concave surface

### Examples of use

Semiconductor chips, Packaging materials, Metal sheet,  
Printing industry, Paper box



### Recommended Lifting Force (Max.)

Model	Volume (cm <sup>3</sup> )	Lifting Force (Kg) - Perpendicular			Lifting Force (Kg) - Parallel		
		- 20 kPa	- 60 kPa	- 90 kPa	- 20 kPa	- 60 kPa	- 90 kPa
VU25	1.50	0.91	1.98	2.50	0.70	0.95	1.05

※ The lifting force above does not include safety factor

### Material Specifications

Material	Hardness Shore (°)	Color	Temperature (°C)
NBR	60	Black	-20~110
Silicone	55	Red	-70~200
White Silicone	55	Translucent White	-70~200
White Silicone (FDA)	55	Translucent White	-70~200
High temp. Silicone	50	Blue	-70~280
Conductive Silicone	70	Smoky Black	-45~90
Urethane	60	Dark Green	0~100
Mark Free	75	Black	-10~100

※ For additional material, see page 32~33

### Material Resistance

Description	NBR	Silicone	White Silicone	High temp. Silicone	Conductive Silicone	Urethane	Mark Free
Wear Resistance	Excellent	Good	Good	Good	Good	Excellent	Good
Oil	Excellent	Poor	Poor	Poor	Poor	Excellent	Excellent
Weather / Ozone	Fair	Excellent	Excellent	Excellent	Excellent	Excellent	Excellent
Alcohol	Good	Good	Good	Good	Good	Fair	Good
Acid	Fair	Poor	Poor	Poor	Poor	Poor	Excellent

### Dimension

[ Unit : mm ]

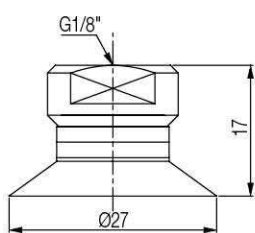

[ With 18F fitting ]

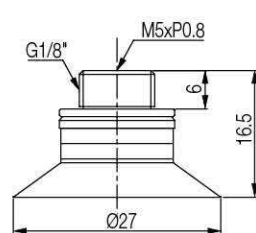

[ With M518F fitting ]

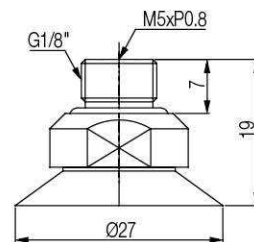

[ With 18MFX fitting ]

## Build an Ordering No.

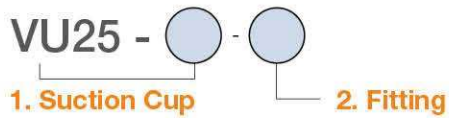

1. Suction cup	Description	Symbol
	Universal suction cup, 25mm diameter, Nitrile (NBR)	VU25-N
	Universal suction cup, 25mm diameter, Silicone	VU25-S
	Universal suction cup, 25mm diameter, White silicone	VU25-WS
	Universal suction cup, 25mm diameter, White silicone (FDA)	VU25-WS (FDA)
	Universal suction cup, 25mm diameter, High temperature silicone	VU25-HS
	Universal suction cup, 25mm diameter, Conductive silicone	VU25-CS
	Universal suction cup, 25mm diameter, Urethane	VU25-U
	Universal suction cup, 25mm diameter, Mark free	VU25-A

2. Fitting	Description	Symbol
	Fitting, G1/8 Male - M5 female	M518MF
	Fitting, G1/8 Male - M5 female, Mesh filter	M-M518MF
	Efficiency valve, Fitting, G1/8Male - M5 Female	M518MF-EV
	Fitting, G1/8 Male - M5 female, Old profile	M518MFO
	Fitting, G1/8 Male - M5 Female, Old profile, Mesh filter	M-M518MFO
	Efficiency valve, Fitting, G1/8Male - M5 Female, Old profile	M518MFO-EV
	Fitting, G1/8 male - M5 female, For silicone material	M518MFX*
	Fitting, G1/8 female	18F
	Fitting, G1/8 female, Mesh filter	M-18F
	Efficiency valve, Fitting, G1/8 Female	18F-EV

\* M518MFX is available only for Silicone material.

## Spare Parts – Rubber Parts

Part No.	Description	Weight (g)	Color
VU25-N	Universal suction cup, 25mm diameter, Nitrile (NBR)	1.45	Black
VU25-S	Universal suction cup, 25mm diameter, Silicone	1.45	Red
VU25-WS	Universal suction cup, 25mm diameter, White silicone	1.45	Translucent White
VU25-WS (FDA)	Universal suction cup, 25mm diameter, White silicone (FDA)	1.45	Translucent White
VU25-HS	Universal suction cup, 25mm diameter, High temperature silicone	1.45	Blue
VU25-CS	Universal suction cup, 25mm diameter, Conductive silicone	1.48	Smoky Black
VU25-U	Universal suction cup, 25mm diameter, Urethane	1.46	Dark Green
VU25-A	Universal suction cup, 25mm diameter, Mark free	1.77	Black

[ Unit : mm ]

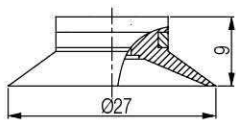

[ Rubber part ]

## Spare Parts – Fittings

Part No. (Code No.)	Fitting size	Description	Weight (g)
350 000 3209	M518MF	G1/8 Male - M5 female	1.82
350 000 5209	M518MF-F	G1/8 Male - M5 female, Mesh filter	1.92
350 010 4209	M518MF-EV	Efficiency valve, G1/8Male - M5 Female	1.94
350 000 1209	M518MFO	G1/8 Male - M5 female, Old profile	2.88
350 000 1109	M518MFO-F	G1/8 Male - M5 Female, Old profile, Mesh filter	2.94
350 010 1209	M518MFO-EV	Efficiency valve, G1/8Male - M5 Female, Old profile	2.87
350 000 3229	M518MFX	G1/8 male - M5 female, For silicone material	3.71
350 000 3310	18F	G1/8 female	3.23
350 000 4310	18F-F	G1/8 female, Mesh filter	3.3
350 010 3310	18F-EV	Efficiency valve, G1/8 female	3.43

# SUCTION CUPS / Universal

## VU30



### Features and Strengths

Excellent performance for flat stable and slightly curved surfaces  
Suitable for concave surface

### Examples of use

Semiconductor chips, Packaging materials, Metal sheet,  
Printing industry, Paper box



### Recommended Lifting Force (Max.)

Model	Volume (cm <sup>3</sup> )	Lifting Force (Kg) - Perpendicular			Lifting Force (Kg) - Parallel		
		- 20 kPa	- 60 kPa	- 90 kPa	- 20 kPa	- 60 kPa	- 90 kPa
VU30	2.00	1.22	2.55	3.06	0.79	1.00	1.12

※ The lifting force above does not include safety factor

### Material Specifications

Material	Hardness Shore (°)	Color	Temperature (°C)
NBR	60	Black	-20~110
Silicone	55	Red	-70~200
White Silicone	55	Translucent White	-70~200
White Silicone (FDA)	55	Translucent White	-70~200
High temp. Silicone	50	Blue	-70~280
Conductive Silicone	70	Smoky Black	-45~90
Urethane	60	Dark Green	0~100
Mark Free	75	Black	-10~100

※ For additional material, see page 32~33

### Material Resistance

Description	NBR	Silicone	White Silicone	High temp. Silicone	Conductive Silicone	Urethane	Mark Free
Wear Resistance	Excellent	Good	Good	Good	Good	Excellent	Good
Oil	Excellent	Poor	Poor	Poor	Poor	Excellent	Excellent
Weather / Ozone	Fair	Excellent	Excellent	Excellent	Excellent	Excellent	Excellent
Alcohol	Good	Good	Good	Good	Good	Fair	Good
Acid	Fair	Poor	Poor	Poor	Poor	Poor	Excellent

### Dimension

[ Unit : mm ]

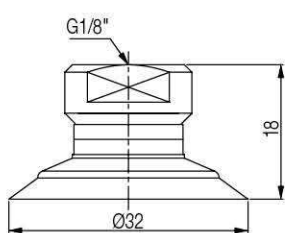

[ With 18F fitting ]

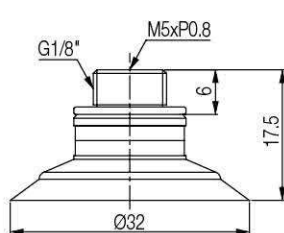

[ With M518MF fitting ]

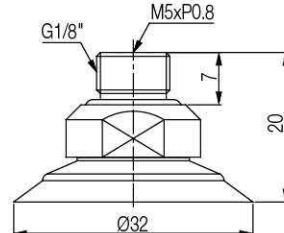

[ With M518MFX fitting ]

## I Build an Ordering No.

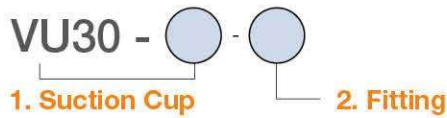

1. Suction cup	Description	Symbol
	Universal suction cup, 30mm diameter, Nitrile (NBR)	VU30-N
	Universal suction cup, 30mm diameter, Silicone	VU30-S
	Universal suction cup, 30mm diameter, White silicone	VU30-WS
	Universal suction cup, 30mm diameter, White silicone (FDA)	VU30-WS (FDA)
	Universal suction cup, 30mm diameter, High temperature silicone	VU30-HS
	Universal suction cup, 30mm diameter, Conductive silicone	VU30-CS
	Universal suction cup, 30mm diameter, Urethane	VU30-U
	Universal suction cup, 30mm diameter, Mark free	VU30-A

2. Fitting	Description	Symbol
	Fitting, G1/8 male - M5 female	M518MF
	Fitting, G1/8 male - M5 female, Mesh filter	M-M518MF
	Efficiency valve, Fitting, G1/8 male - M5 female	M518MF-EV
	Fitting, G1/8 male - M5 female, Old profile	M518MFO
	Fitting, G1/8 male - M5 Female, Old profile, Mesh filter	M-M518MFO
	Efficiency valve, Fitting, G1/8 male - M5 female, Old profile	M518MFO-EV
	Fitting, G1/8 male - M5 female, For silicone material	M518MFX*
	Fitting, G1/8 female	18F
	Fitting, G1/8 female, Mesh filter	M-18F
	Efficiency valve, Fitting, G1/8 female	18F-EV

\* M518MFX\* is available only for Silicone material.

## I Spare Parts – Rubber Parts

Part No.	Description	Weight (g)	Color
VU30-N	Universal suction cup, 30mm diameter, Nitrile (NBR)	2.04	Black
VU30-S	Universal suction cup, 30mm diameter, Silicone	1.96	Red
VU30-WS	Universal suction cup, 30mm diameter, White silicone	1.96	Translucent White
VU30-WS (FDA)	Universal suction cup, 30mm diameter, White silicone (FDA)	1.96	Translucent White
VU30-HS	Universal suction cup, 30mm diameter, High temperature silicone	1.96	Blue
VU30-CS	Universal suction cup, 30mm diameter, Conductive silicone	2.01	Smoky Black
VU30-U	Universal suction cup, 30mm diameter, Urethane	1.97	Dark Green
VU30-A	Universal suction cup, 30mm diameter, Mark free	2.55	Black

[ Unit : mm ]

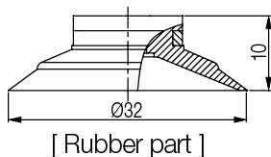

## I Spare Parts – Fittings

Part No. (Code No.)	Fitting size	Description	Weight (g)
350 000 3209	M518MF	G1/8 male - M5 female	1.82
350 000 5209	M518MF-F	G1/8 male - M5 female, Mesh filter	1.92
350 010 4209	M518MF-EV	Efficiency valve, G1/8 male - M5 female	1.94
350 000 1209	M518MFO	G1/8 male - M5 female, Old profile	2.88
350 000 1109	M518MFO-F	G1/8 male - M5 Female, Old profile, Mesh filter	2.94
350 010 1209	M518MFO-EV	Efficiency valve, G1/8 male - M5 female, Old profile	2.87
350 000 3229	M518MFX	G1/8 male - M5 female, For silicone material	3.71
350 000 3310	18F	G1/8 female	3.23
350 000 4310	18F-F	G1/8 female, Mesh filter	3.3
350 010 3310	18F-EV	Efficiency valve, G1/8 female	3.43

# SUCTION CUPS / Universal

## VU30-X

### Features and Strengths

Developed to be used specially for bag opening application  
Suitable to be used in thin plastic and film type material

### Examples of use

Plastic bag opening, Thin Film Material, Paper Bag Handling



### Recommended Lifting Force (Max.)

Model	Volume (cm <sup>3</sup> )	Lifting Force (Kg) - Perpendicular		
		- 20 kPa	- 60 kPa	- 90 kPa
VU30X	1.80	0.65	1.48	1.78

※ The lifting force above does not include safety factor

### Material Specifications

Material	Hardness Shore (°)	Color	Temperature (°C)
NBR	60	Black	-20~110
Silicone	55	Red	-70~200
White Silicone	55	Translucent White	-70~200
White Silicone (FDA)	55	Translucent White	-70~200
High temp. Silicone	50	Blue	-70~280
Conductive Silicone	70	Smoky Black	-45~90
Urethane	60	Dark Green	0~100

### Material Resistance

Description	NBR	Silicone	White Silicone	High temp. Silicone	Conductive Silicone	Urethane
Wear Resistance	Excellent	Good	Good	Good	Good	Excellent
Oil	Excellent	Poor	Poor	Poor	Poor	Excellent
Weather / Ozone	Fair	Excellent	Excellent	Excellent	Excellent	Excellent
Alcohol	Good	Good	Good	Good	Good	Fair
Acid	Fair	Poor	Poor	Poor	Poor	Poor

## Build an Ordering No.

### VU30X -

1. Suction Cup

1. Suction cup	Description	Weight (g)	Symbol
	Customized suction cup, 30mm diameter, Nitrile (NBR)	1.05	VU30X-N
	Customized suction cup, 30mm diameter, Silicone	0.9	VU30X-S
	Customized suction cup, 30mm diameter, White silicone	1.02	VU30X-WS
	Customized suction cup, 30mm diameter, White silicone (FDA)	1.02	VU30X-WS(FDA)
	Customized suction cup, 30mm diameter, High temperature silicone	1.08	VU30X-HS
	Customized suction cup, 30mm diameter, Conductive silicone	1.04	VU30X-CS
	Customized suction cup, 30mm diameter, Urethane	1.08	VU30X-U

## Dimension

[ Unit : mm ]

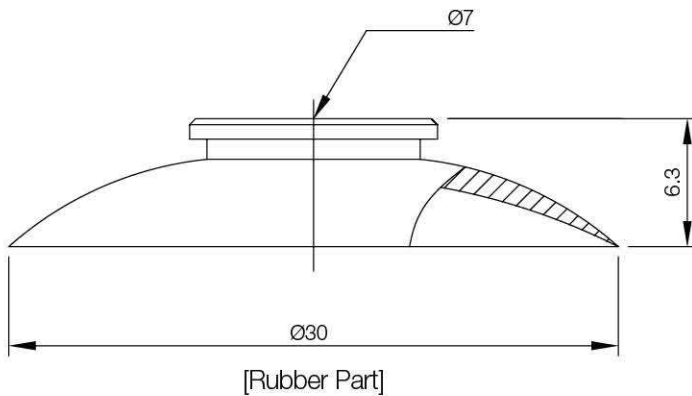

# SUCTION CUPS / Universal

## VU40



### Features and Strengths

Excellent performance for flat stable and slightly curved surfaces  
Suitable for concave surface

### Examples of use

Semiconductor chips, Packaging materials, Metal sheet,  
Printing industry, Paper box



### Recommended Lifting Force (Max.)

Model	Volume (cm <sup>3</sup> )	Lifting Force (Kg) - Perpendicular			Lifting Force (Kg) - Parallel		
		- 20 kPa	- 60 kPa	- 90 kPa	- 20 kPa	- 60 kPa	- 90 kPa
VU40	5.50	2.04	3.97	5.00	1.42	2.24	2.80

※ The lifting force above does not include safety factor

### Material Specifications

Material	Hardness Shore (°)	Color	Temperature (°C)
NBR	60	Black	-20~110
Silicone	55	Red	-70~200
White Silicone	55	Translucent White	-70~200
White Silicone (FDA)	55	Translucent White	-70~200
High temp. Silicone	50	Blue	-70~280
Conductive Silicone	70	Smoky Black	-45~90
Urethane	60	Dark Green	0~100
Mark Free	75	Black	-10~100

※ For additional material, see page 32~33

### Material Resistance

Description	NBR	Silicone	White Silicone	High temp. Silicone	Conductive Silicone	Urethane	Mark Free
Wear Resistance	Excellent	Good	Good	Good	Good	Excellent	Good
Oil	Excellent	Poor	Poor	Poor	Poor	Excellent	Excellent
Weather / Ozone	Fair	Excellent	Excellent	Excellent	Excellent	Excellent	Excellent
Alcohol	Good	Good	Good	Good	Good	Fair	Good
Acid	Fair	Poor	Poor	Poor	Poor	Poor	Excellent

### Dimension

[ Unit : mm ]

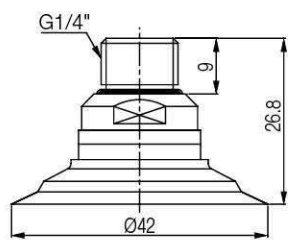

[ With 14M fitting ]

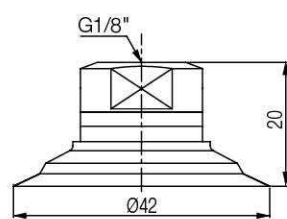

[ With 18F fitting ]

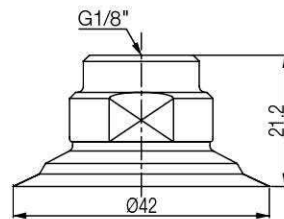

[ With 18FX fitting ]

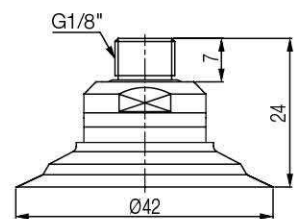

[ With 18M fitting ]

## I Build an Ordering No.

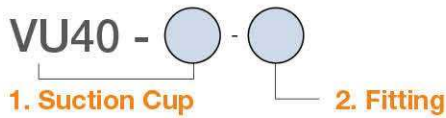

1. Suction cup	Description	Symbol
	Universal suction cup, 40mm diameter, Nitrile (NBR)	VU40-N
	Universal suction cup, 40mm diameter, Silicone	VU40-S
	Universal suction cup, 40mm diameter, White silicone	VU40-WS
	Universal suction cup, 40mm diameter, White silicone (FDA)	VU40-WS (FDA)
	Universal suction cup, 40mm diameter, High temperature silicone	VU40-HS
	Universal suction cup, 40mm diameter, Conductive silicone	VU40-CS
	Universal suction cup, 40mm diameter, Urethane	VU40-U
	Universal suction cup, 40mm diameter, Mark free	VU40-A
2. Fitting	Description	Symbol
	Fitting, G1/8 female	18F
	Fitting, G1/8 female, Mesh filter	M-18F
	Efficiency valve, Fitting, G1/8 female	18F-EV
	Fitting, G1/8 female, For silicone material	18FX*
	Fitting, G1/8 female, Old profile	18FO
	Fitting, G1/8 female, Old profile, Mesh filter	M-18FO
	Fitting, G1/8 male	18M
	Fitting, G1/8 male, Mesh filter	M-18M
	Efficiency valve, Fitting, G1/8 male	18M-EV
	Fitting, G1/4 male	14M
	Fitting, G1/4 male, Mesh filter	M-14M
	Efficiency valve, Fitting, G1/4 male	14M-EV

\* 18FX is available only for Silicone material.

## I Spare Parts – Rubber Parts

Part No.	Description	Weight (g)	Color
VU40-N	Universal suction cup, 40mm diameter, Nitrile (NBR)	4.77	Black
VU40-S	Universal suction cup, 40mm diameter, Silicone	4.51	Red
VU40-WS	Universal suction cup, 40mm diameter, White silicone	4.51	Translucent White
VU40-WS (FDA)	Universal suction cup, 40mm diameter, White silicone (FDA)	4.51	Translucent White
VU40-HS	Universal suction cup, 40mm diameter, High temperature silicone	4.51	Blue
VU40-CS	Universal suction cup, 40mm diameter, Conductive silicone	4.57	Smoky Black
VU40-U	Universal suction cup, 40mm diameter, Urethane	4.78	Dark Green
VU40-A	Universal suction cup, 40mm diameter, Mark free	5.85	Black

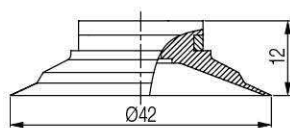

[ Rubber part ]

[ Unit : mm ]

## I Spare Parts – Fittings

Part No. (Code No.)	Fitting size	Description	Weight (g)
350 000 3311	18F	G1/8 female	5.62
350 000 4311	18F-F	G1/8 female, Mesh filter	5.72
350 010 3311	18F-EV	Efficiency valve, G1/8 female	5.86
350 000 3321	18FX	G1/8 female, For silicone material	8.46
350 000 2311	18FO	G1/8 female, Old profile	8.24
350 000 4811	18FO-F	G1/8 female, Old profile, Mesh filter	8.41
350 000 2304	18M	G1/8 male	4.93
350 000 4304	18M-F	G1/8 male, Mesh filter	5.07
350 010 2304	18M-EV	Efficiency valve, G1/8 male	5.21
350 000 3404	14M	G1/4 male	5.79
350 000 3804	14M-F	G1/4 male, Mesh filter	5.88
350 010 3404	14M-EV	Efficiency valve, G1/4 male	6.02

# SUCTION CUPS / Universal

## VU50



### Features and Strengths

Excellent performance for flat stable and slightly curved surfaces  
Suitable for concave surface

### Examples of use

Semiconductor chips, Packaging materials, Metal sheet,  
Printing industry, Paper box

### Recommended Lifting Force (Max.)

Model	Volume (cm <sup>3</sup> )	Lifting Force (Kg) - Perpendicular			Lifting Force (Kg) - Parallel		
		- 20 kPa	- 60 kPa	- 90 kPa	- 20 kPa	- 60 kPa	- 90 kPa
VU50	12.00	3.57	7.44	9.38	2.04	3.77	4.48

※ The lifting force above does not include safety factor

### Material Specifications

Material	Hardness Shore (°)	Color	Temperature (°C)
NBR	60	Black	-20~110
Silicone	55	Red	-70~200
White Silicone	55	Translucent White	-70~200
White Silicone (FDA)	55	Translucent White	-70~200
High temp. Silicone	50	Blue	-70~280
Conductive Silicone	70	Smoky Black	-45~90
Urethane	60	Dark Green	0~100
Mark Free	75	Black	-10~100

※ For additional material, see page 32~33

### Material Resistance

Description	NBR	Silicone	White Silicone	High temp. Silicone	Conductive Silicone	Urethane	Mark Free
Wear Resistance	Excellent	Good	Good	Good	Good	Excellent	Good
Oil	Excellent	Poor	Poor	Poor	Poor	Excellent	Excellent
Weather / Ozone	Fair	Excellent	Excellent	Excellent	Excellent	Excellent	Excellent
Alcohol	Good	Good	Good	Good	Good	Fair	Good
Acid	Fair	Poor	Poor	Poor	Poor	Poor	Excellent

### Dimension

[ Unit : mm ]

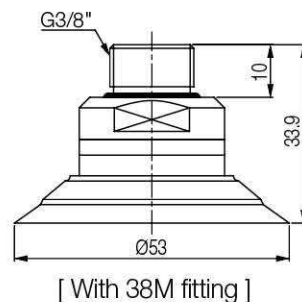
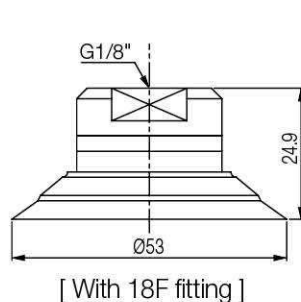
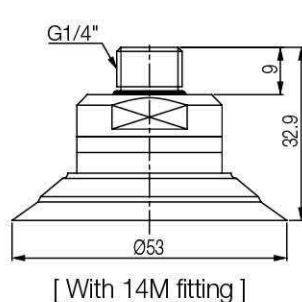

## I Build an Ordering No.

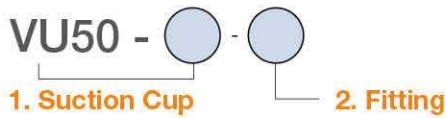

1. Suction cup	Description	Symbol
	Universal suction cup, 50mm diameter, Nitrile (NBR)	VU50-N
	Universal suction cup, 50mm diameter, Silicone	VU50-S
	Universal suction cup, 50mm diameter, White silicone	VU50-WS
	Universal suction cup, 50mm diameter, White silicone (FDA)	VU50-WS (FDA)
	Universal suction cup, 50mm diameter, High temperature silicone	VU50-HS
	Universal suction cup, 50mm diameter, Conductive silicone	VU50-CS
	Universal suction cup, 50mm diameter, Urethane	VU50-U
	Universal suction cup, 50mm diameter, Mark free	VU50-A
2. Fitting	Description	Symbol
	Fitting, G1/8 female	18F
	Fitting, G1/8 female, Mesh filter	M-18F
	Efficiency valve, Fitting, G1/8 Female	18F-EV
	Fitting, G1/8 female, Old profile	18FO
	Fitting, G1/8 female, Old profile, Mesh filter	M-18FO
	Efficiency valve, Fitting, G1/8 female, Old profile	18FO-EV
	Fitting, G1/4 male	14M
	Fitting, G1/4 male, Mesh filter	M-14M
	Efficiency valve, Fitting, G1/4 male	14M-EV
	Fitting, G3/8 male	38M
	Fitting, G3/8 male, Mesh filter	M-38M
	Efficiency valve, Fitting, G3/8 male	38M-EV

## I Spare Parts – Rubber Parts

Part No.	Description	Weight (g)	Color
VU50-N	Universal suction cup, 50mm diameter, Nitrile (NBR)	10.51	Black
VU50-S	Universal suction cup, 50mm diameter, Silicone	10.22	Red
VU50-WS	Universal suction cup, 50mm diameter, White silicone	10.22	Translucent White
VU50-WS (FDA)	Universal suction cup, 50mm diameter, White silicone (FDA)	10.22	Translucent White
VU50-HS	Universal suction cup, 50mm diameter, High temperature silicone	10.22	Blue
VU50-CS	Universal suction cup, 50mm diameter, Conductive silicone	10.29	Smoky Black
VU50-U	Universal suction cup, 50mm diameter, Urethane	10.50	Dark Green
VU50-A	Universal suction cup, 50mm diameter, Mark free	13.05	Black

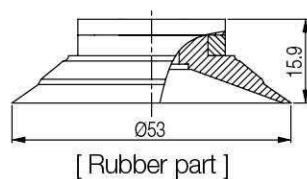

[ Unit : mm ]

## I Spare Parts – Fittings

Part No. (Code No.)	Fitting size	Description	Weight (g)
350 000 3312	18F	G1/8 female	14.47
350 000 4312	18F-F	G1/8 female, Mesh filter	14.58
350 010 3312	18F-EV	Efficiency valve, G1/8 female	15.81
350 000 1312	18FO	G1/8 female, Old profile	10.12
350 000 4912	18FO-F	G1/8 female, Old profile, Mesh filter	10.2
350 010 1312	18FO-EV	Efficiency valve, G1/8 female, Old profile	10.22
350 000 3405	14M	G1/4 male	14.18
350 000 3805	14M-F	G1/4 male, Mesh filter	14.42
350 010 3405	14M-EV	Efficiency valve, G1/4 male	14.38
350 000 3505	38M	G3/8 male	18.14
350 000 3905	38M-F	G3/8 male, Mesh filter	17.75
350 010 3505	38M-EV	Efficiency valve, G3/8 male	17.53

# SUCTION CUPS / Universal

## VU80



### Features and Strengths

Excellent performance for flat stable and slightly curved surfaces  
Suitable for concave surface

### Examples of use

Semiconductor chips, Packaging materials, Metal sheet,  
Printing industry, Paper box

### Recommended Lifting Force (Max.)

Model	Volume (cm <sup>3</sup> )	Lifting Force (Kg) - Perpendicular			Lifting Force (Kg) - Parallel		
		- 20 kPa	- 60 kPa	- 90 kPa	- 20 kPa	- 60 kPa	- 90 kPa
VU80	32.00	7.77	19.80	25.21	4.53	12.70	16.94

※ The lifting force above does not include safety factor

### Material Specifications

Material	Hardness Shore (°)	Color	Temperature (°C)
NBR	60	Black	-20~110
Silicone	55	Red	-70~200
White Silicone	55	Translucent White	-70~200
White Silicone (FDA)	55	Translucent White	-70~200
High temp. Silicone	50	Blue	-70~280
Conductive Silicone	70	Smoky Black	-45~90
Urethane	60	Dark Green	0~100
Mark Free	75	Black	-10~100

※ For additional material, see page 32~33

### Material Resistance

Description	NBR	Silicone	White Silicone	High temp. Silicone	Conductive Silicone	Urethane	Mark Free
Wear Resistance	Excellent	Good	Good	Good	Good	Excellent	Good
Oil	Excellent	Poor	Poor	Poor	Poor	Excellent	Excellent
Weather / Ozone	Fair	Excellent	Excellent	Excellent	Excellent	Excellent	Excellent
Alcohol	Good	Good	Good	Good	Good	Fair	Good
Acid	Fair	Poor	Poor	Poor	Poor	Poor	Excellent

### Dimension

[ Unit : mm ]

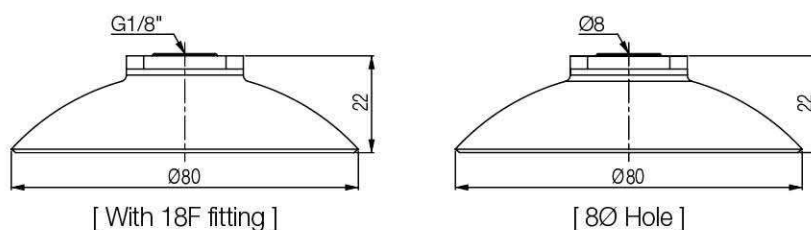

## I Build an Ordering No.



: Pre-mounted fitting

1. Suction cup	Description	Weight (g)	Symbol
	Universal suction cup, 80mm diameter, Nitrile (NBR), G1/8 female fitting	35.65	VU80-N-18F
	Universal suction cup, 80mm diameter, Silicone, G1/8 female fitting	30.84	VU80-S-18F
	Universal suction cup, 80mm diameter, White silicone, G1/8 female fitting	30.83	VU80-WS-18F
	Universal suction cup, 80mm diameter, White silicone (FDA), G1/8 female fitting	30.83	VU80-WS-18F (FDA)
	Universal suction cup, 80mm diameter, High temperature silicone, G1/8 female fitting	31.39	VU80-HS-18F
	Universal suction cup, 80mm diameter, Conductive silicone, G1/8 female fitting	34.1	VU80-CS-18F
	Universal suction cup, 80mm diameter, Urethane, G1/8 female fitting	32.98	VU80-U-18F
	Universal suction cup, 80mm diameter, Mark free, G1/8 female fitting	29.3	VU80-A-18F
	Universal suction cup, 80mm diameter, Nitrile (NBR), 8Ø hole	33.77	VU80-N
	Universal suction cup, 80mm diameter, Silicone, 8Ø hole	29.99	VU80-S
	Universal suction cup, 80mm diameter, White silicone, 8Ø hole	28.26	VU80-WS
	Universal suction cup, 80mm diameter, White silicone (FDA), 8Ø hole	28.26	VU80-WS (FDA)
	Universal suction cup, 80mm diameter, High temperature silicone, 8Ø hole	29.73	VU80-HS
	Universal suction cup, 80mm diameter, Conductive silicone, 8Ø hole	32.3	VU80-CS
	Universal suction cup, 80mm diameter, Urethane, 8Ø hole	30.46	VU80-U
	Universal suction cup, 80mm diameter, Mark free, 8Ø hole	29.3	VU80-A